

This Page Is Inserted by IFW Operations
and is not a part of the Official Record

BEST AVAILABLE IMAGES

Defective images within this document are accurate representations of the original documents submitted by the applicant.

Defects in the images may include (but are not limited to):

- BLACK BORDERS
- TEXT CUT OFF AT TOP, BOTTOM OR SIDES
- FADED TEXT
- ILLEGIBLE TEXT
- SKEWED/SLANTED IMAGES
- COLORED PHOTOS
- BLACK OR VERY BLACK AND WHITE DARK PHOTOS
- GRAY SCALE DOCUMENTS

IMAGES ARE BEST AVAILABLE COPY.

**As rescanning documents *will not* correct images,
please do not report the images to the
Image Problem Mailbox.**

FIG. 1

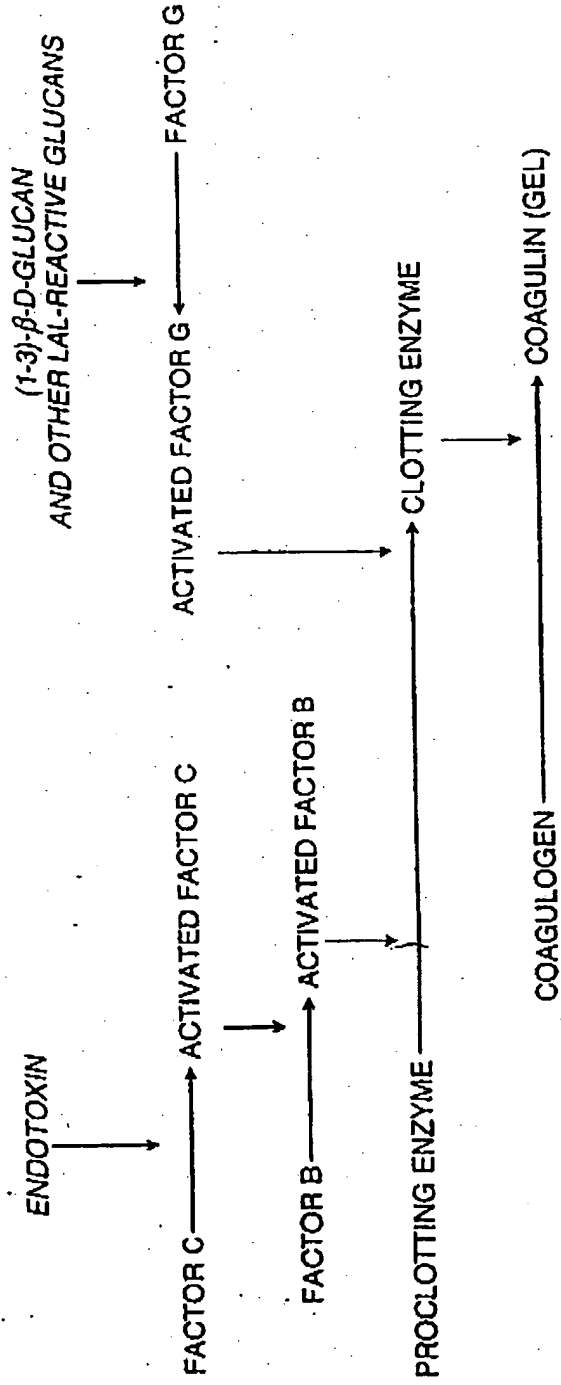

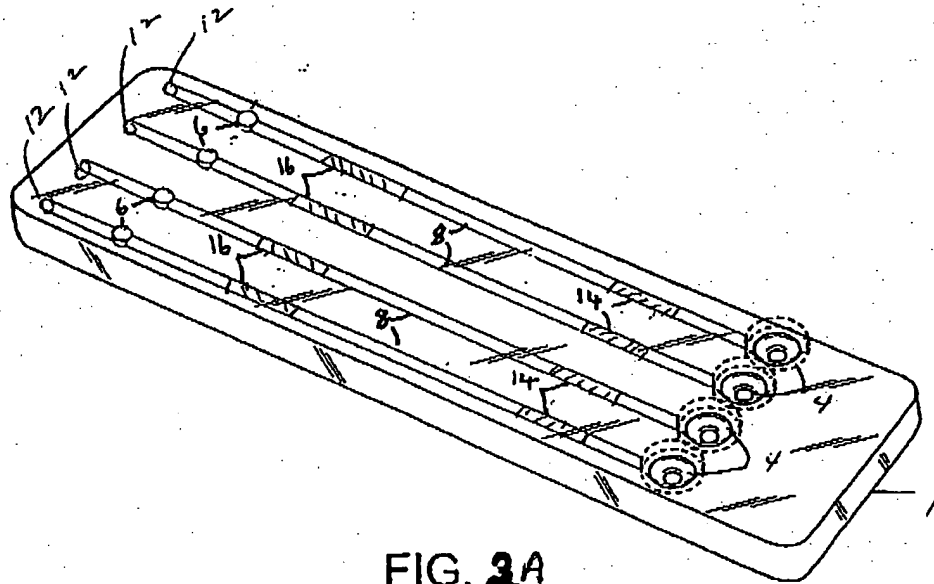

FIG. 2A

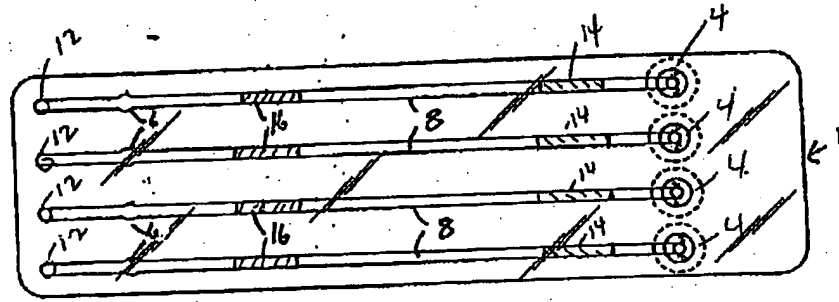

Figure 2B



Figure 2C

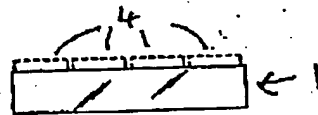

Figure 2D

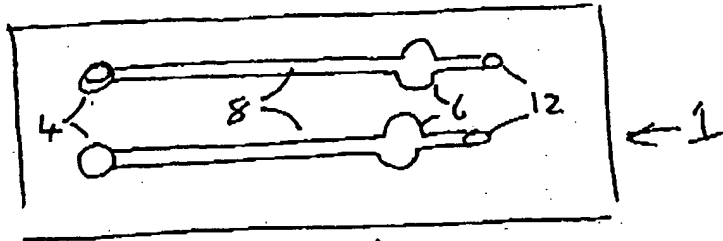

FIG 3 A

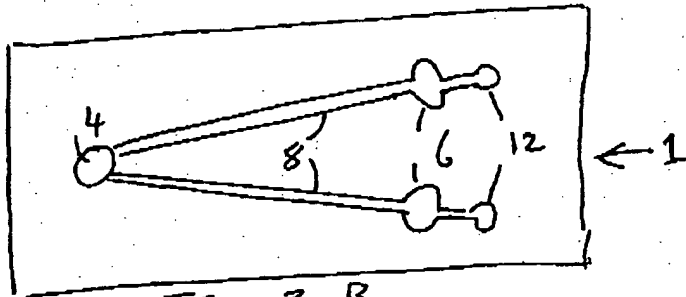

FIG 3 B

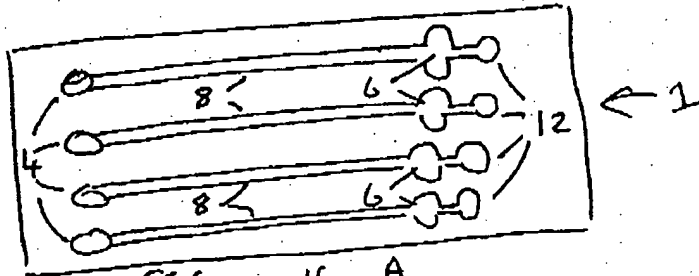

FIG 4 A

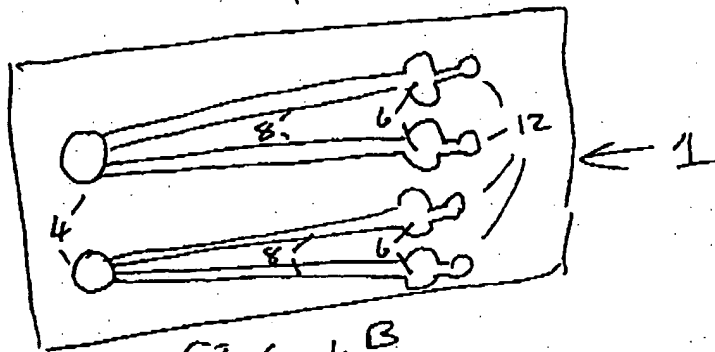

FIG 4 B

Title: METHODS AND COMPOSITIONS FOR THE
DETECTION OF MICROBIAL CONTAMINANTS

Inventors: Wainwright *et al.*

Express Mail Label No. EV334229246US

Atty Docket No.: CHR-004

Attorney for Applicants: Diana M. Steel

Sheet 5 of 22

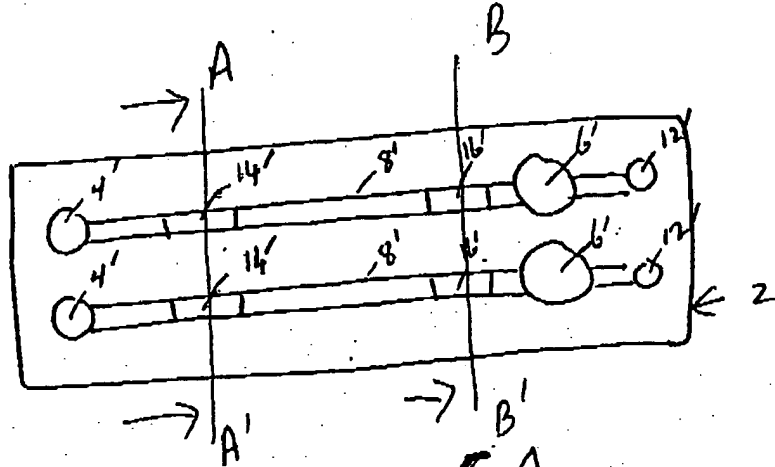

Figure 5A

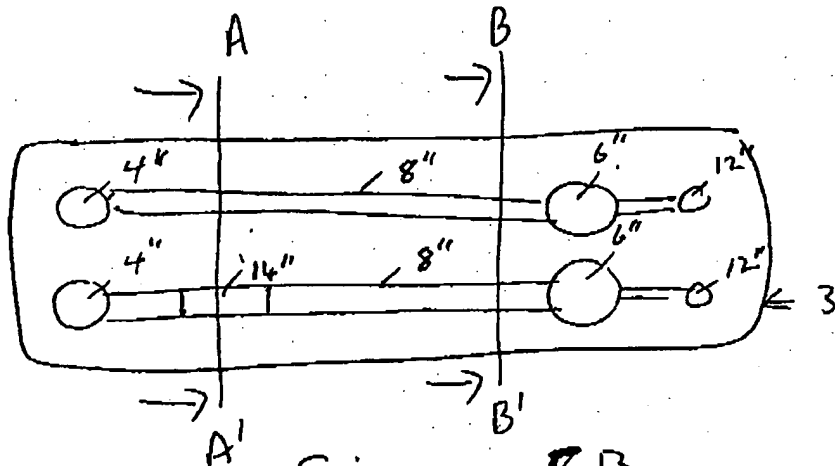

Figure 5B

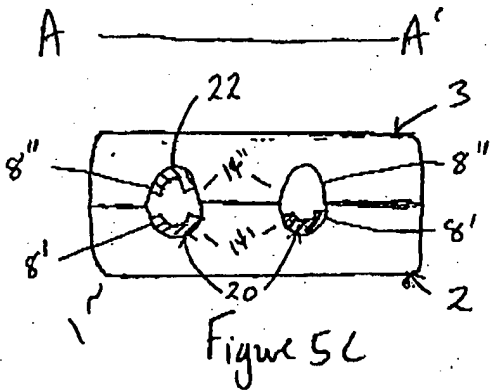

Figure 5C

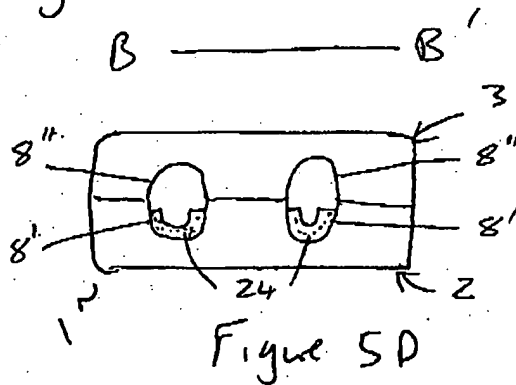
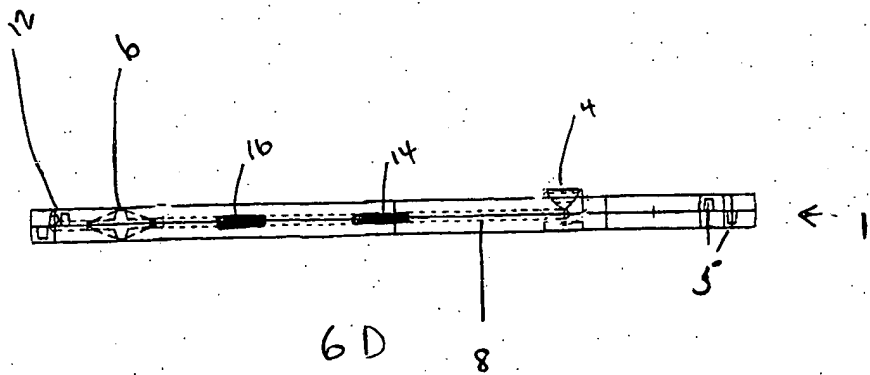
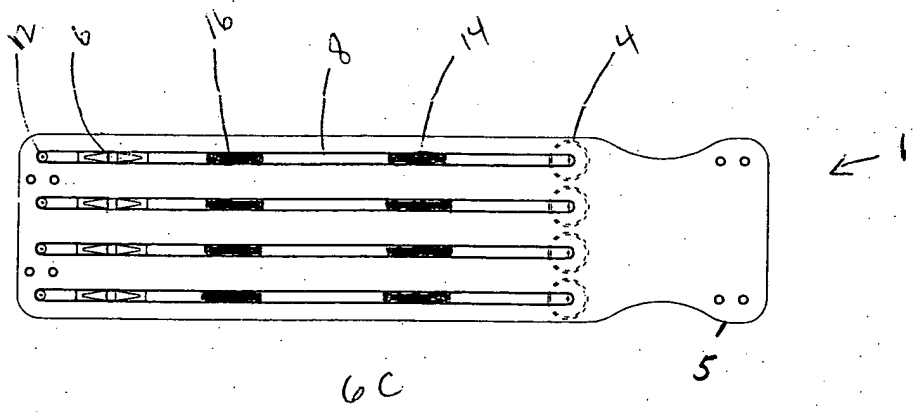
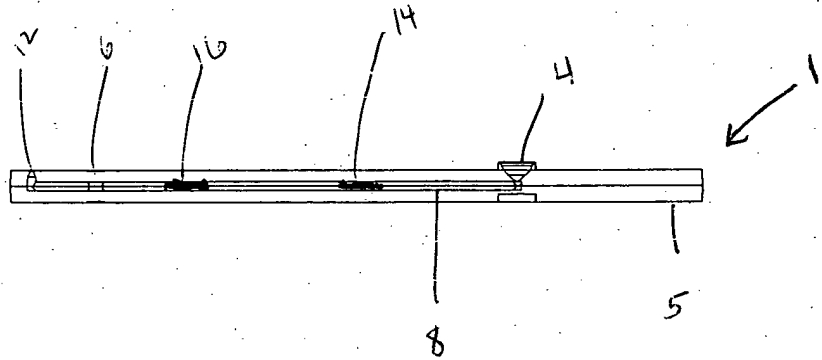
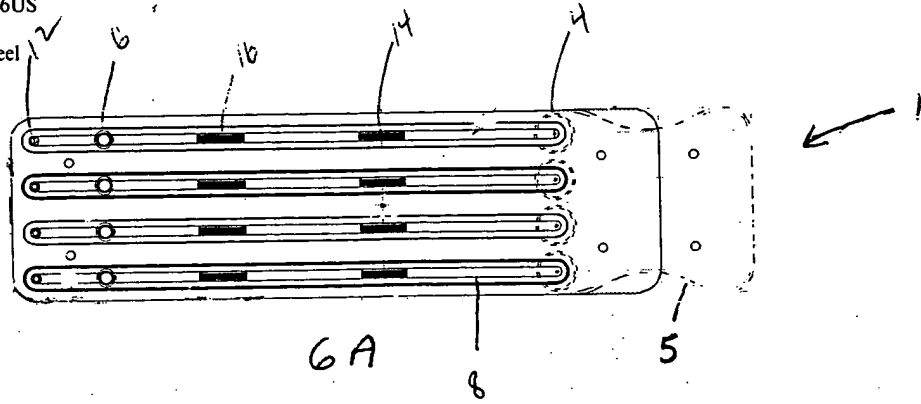

Figure 5D

Title: METHODS AND COMPOSITIONS FOR THE DETECTION OF MICROBIAL CONTAMINANTS

Inventors: Wainwright *et al.*
Express Mail Label No. EV334229246US
Atty Docket No.: CHR-004
Attorney for Applicants: Diana M. Steel
Sheet 6 of 22



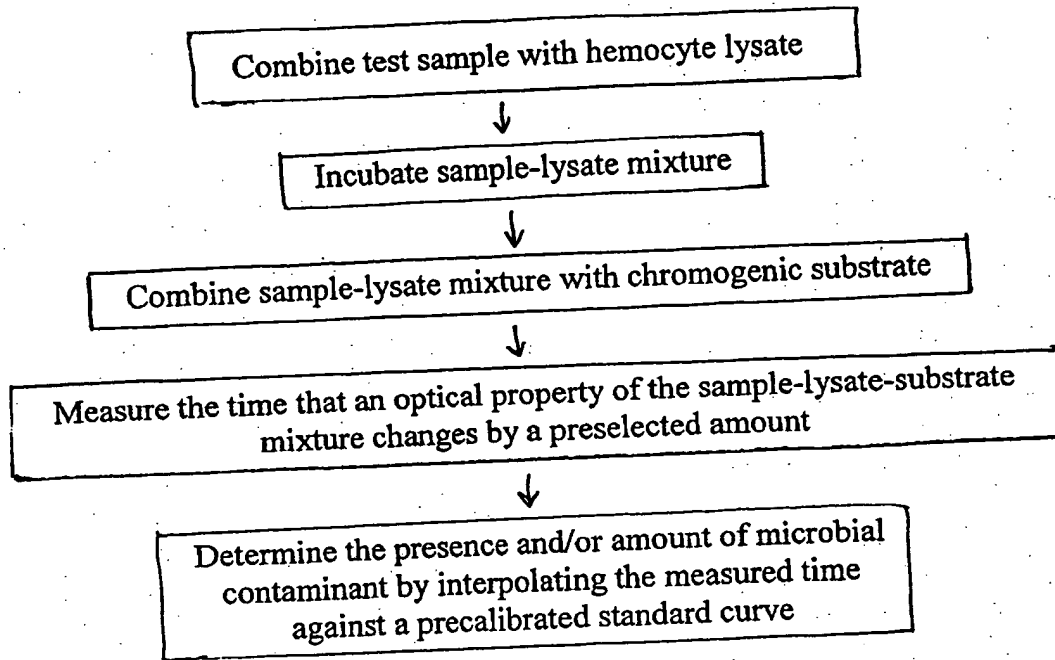

Figure 7

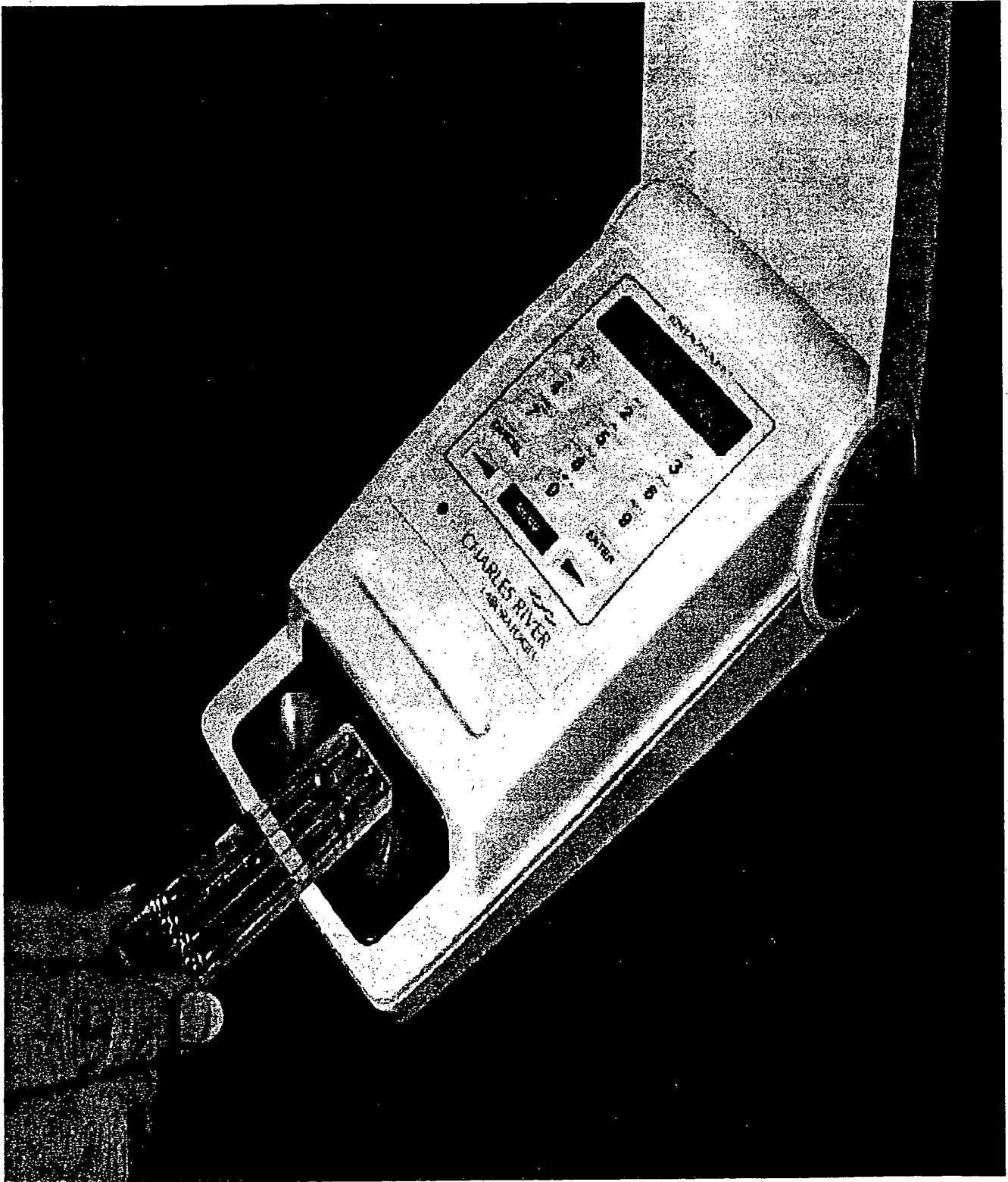

Figure 8A

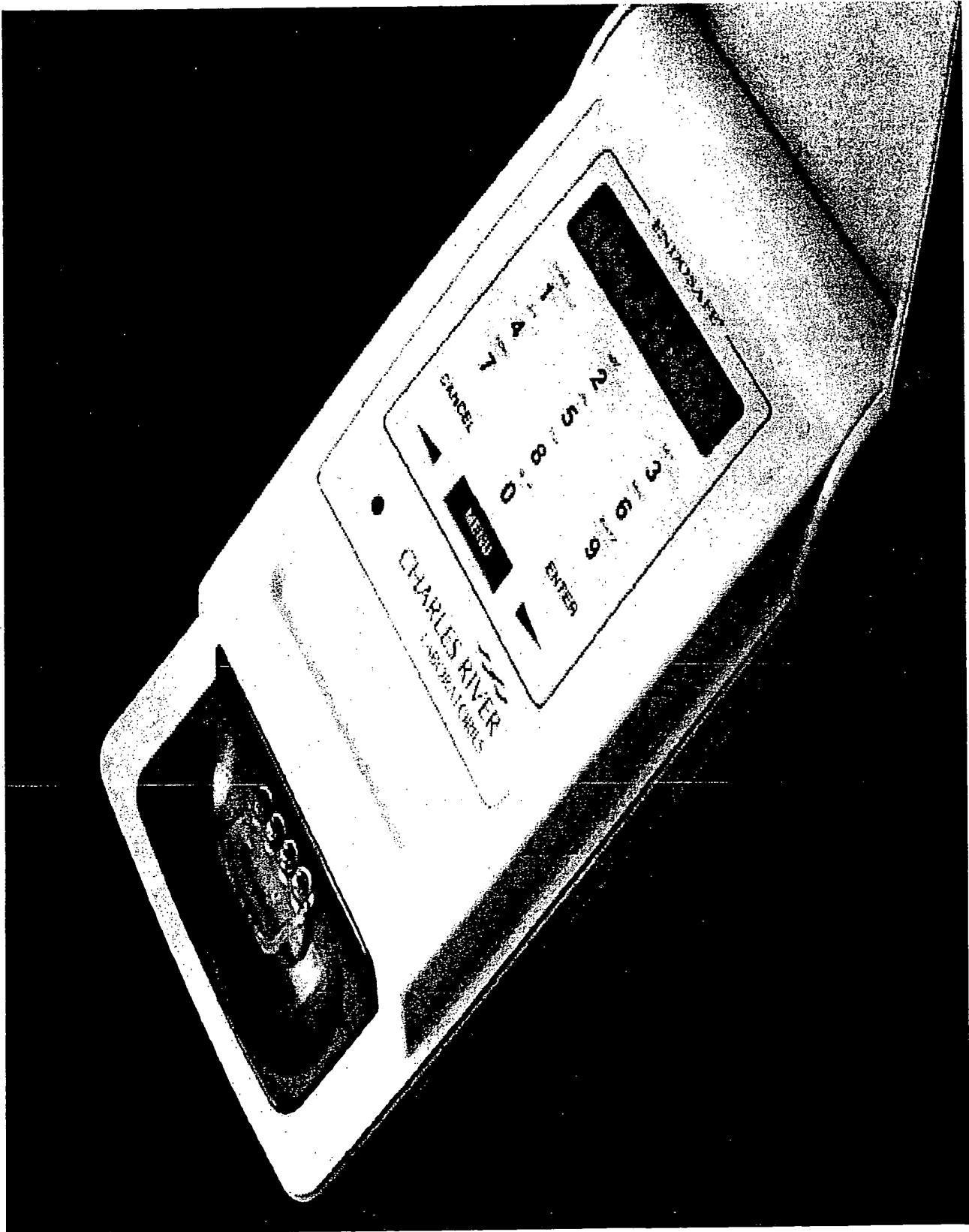

Figure 8B

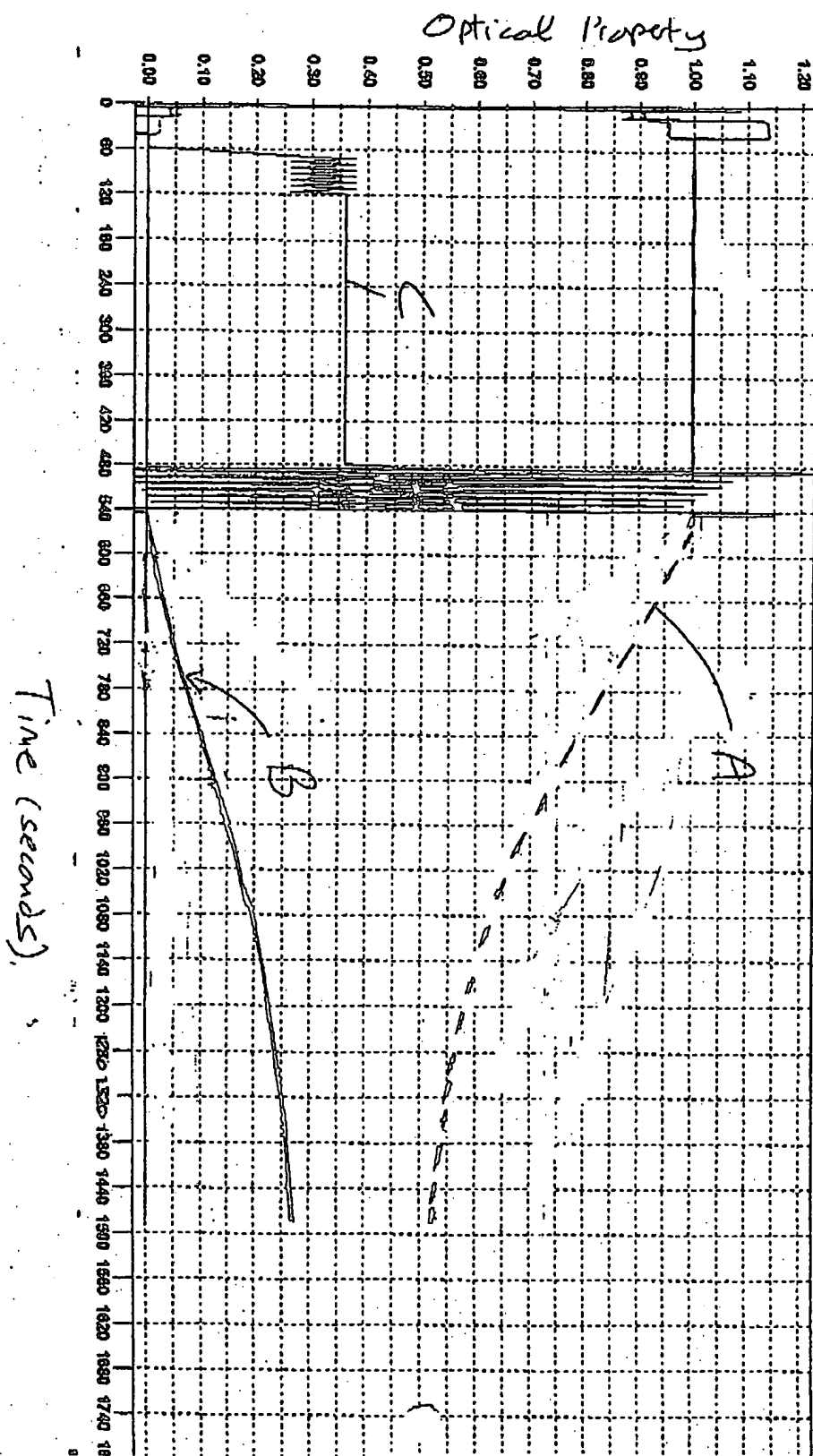

Figure 9

Title: METHODS AND COMPOSITIONS FOR THE
DETECTION OF MICROBIAL CONTAMINANTS

Inventors: Wainwright *et al.*
Express Mail Label No. EV334229246US
Atty Docket No.: CHR-004
Attorney for Applicants: Diana M. Steel
Sheet 11 of 22

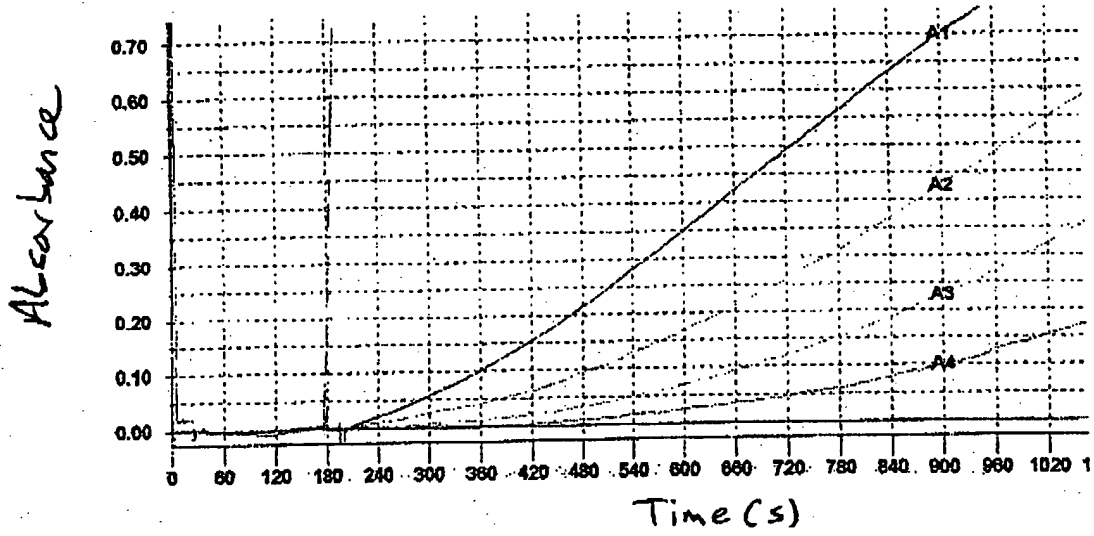

Figure 10A

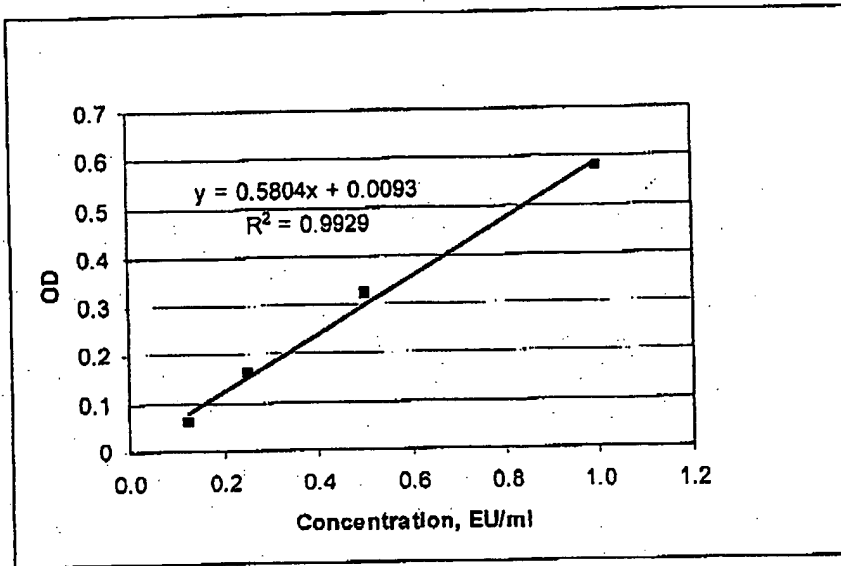

Figure 10B

5EU

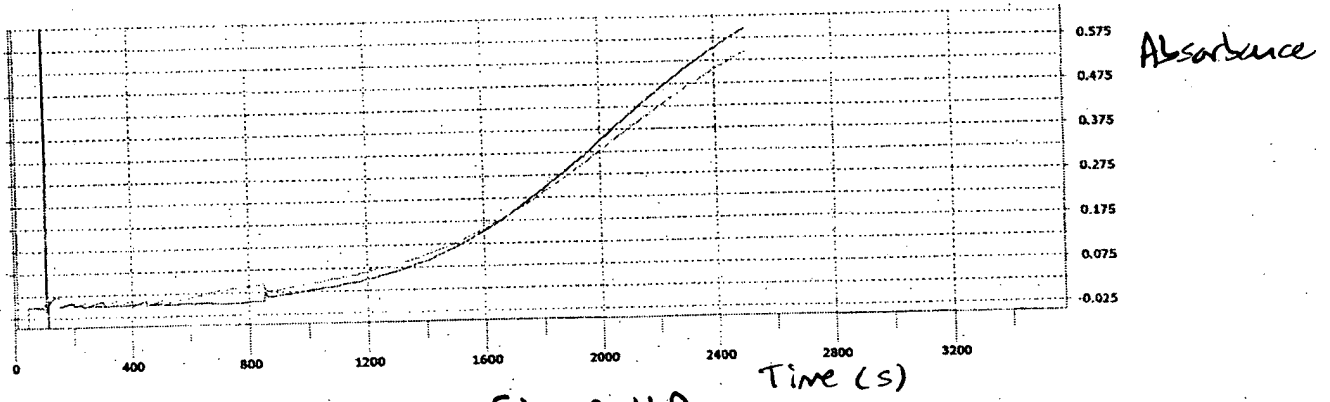

Figure 11A

0.5 EU

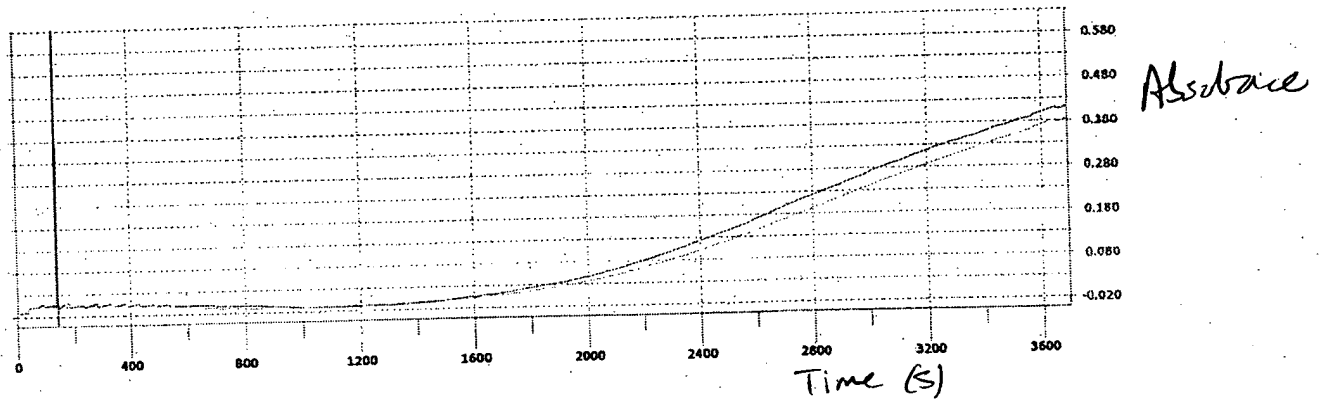

Figure 11 B

0.05 EU

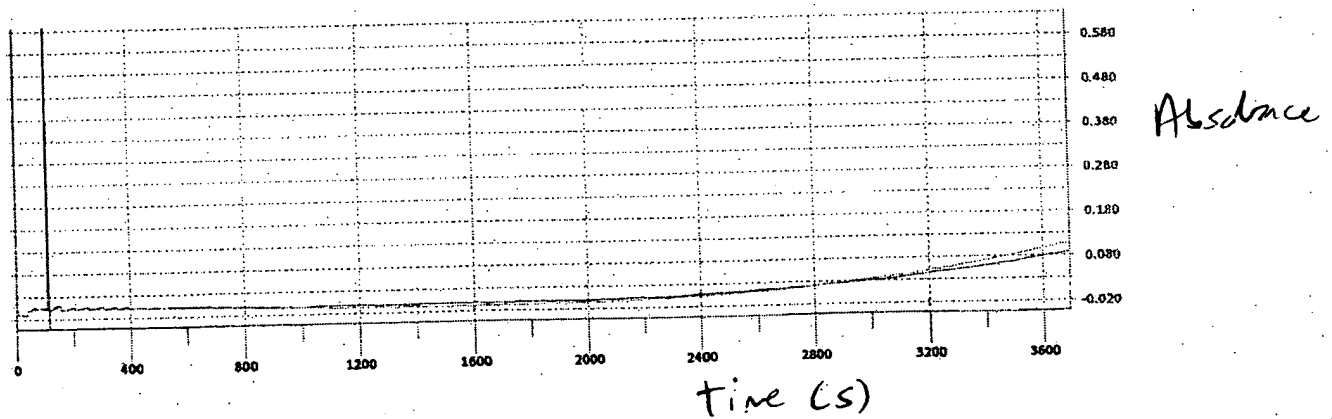

Figure 11.C

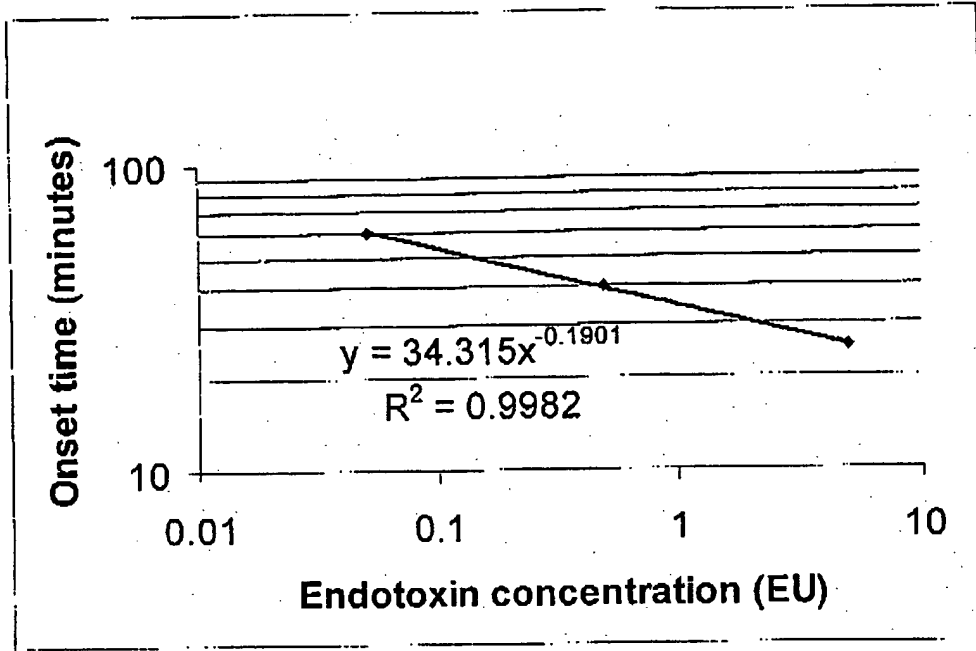

Figure 11.D

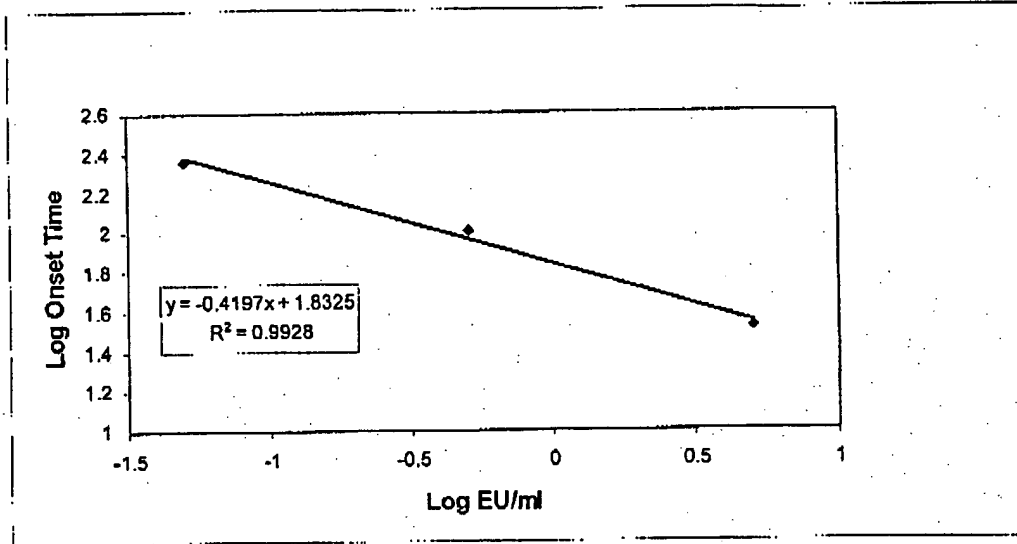

Figure 12

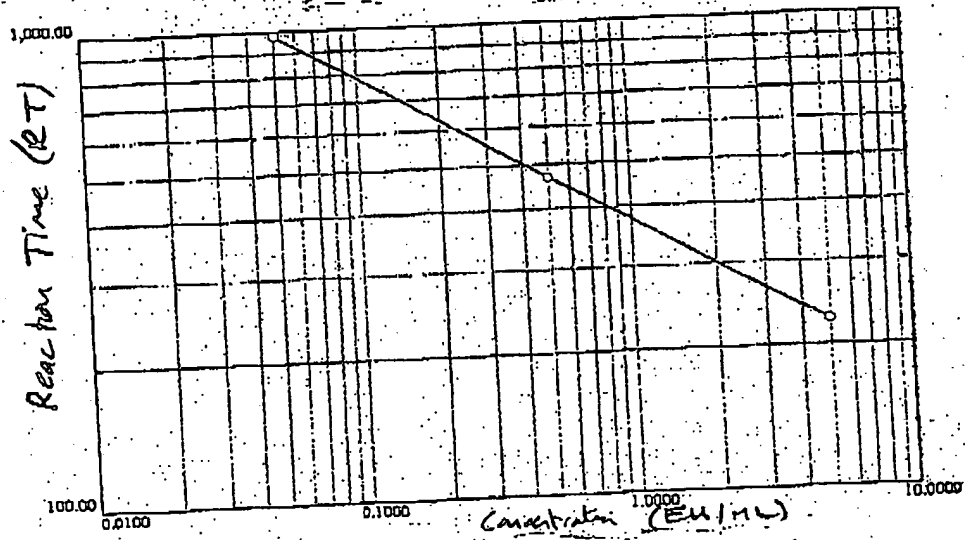

Figure 13

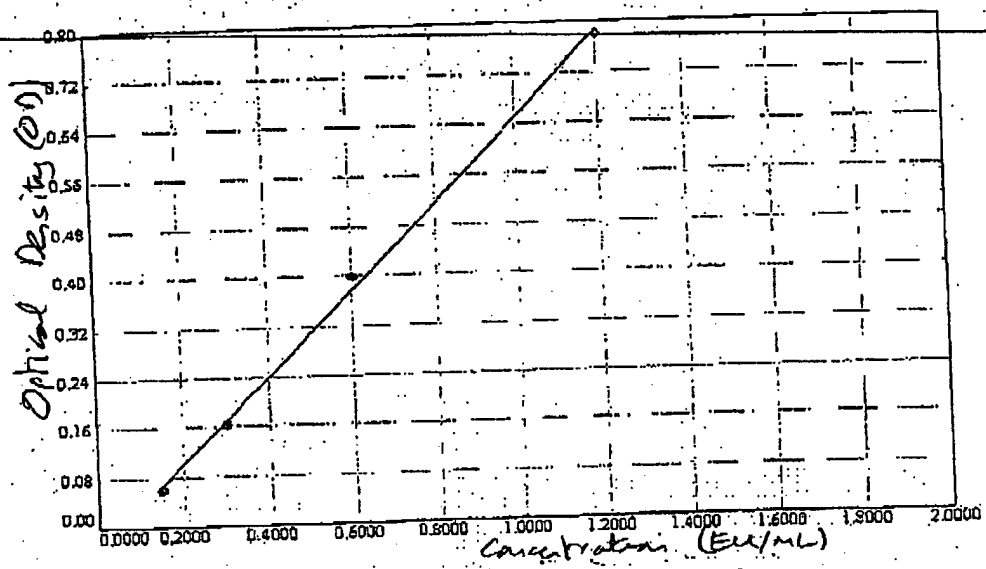

Figure 14

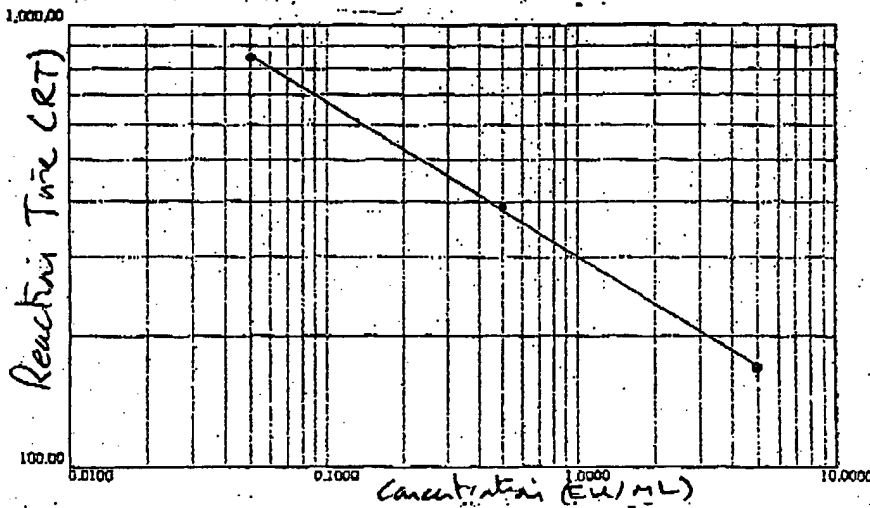

Figure 15

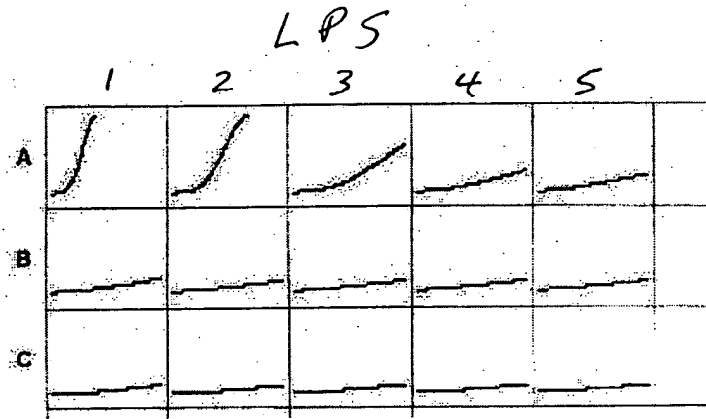

Figure 16A

Glucan

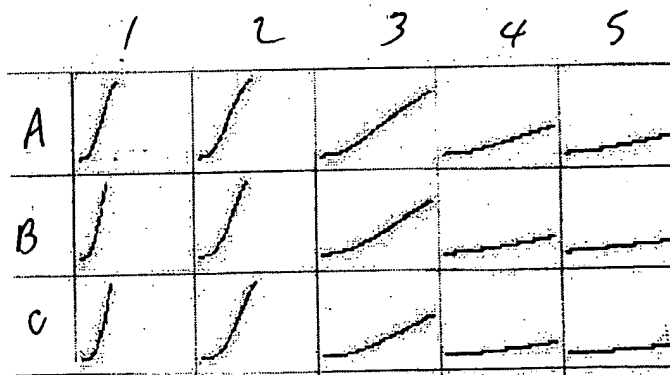

figure 16B

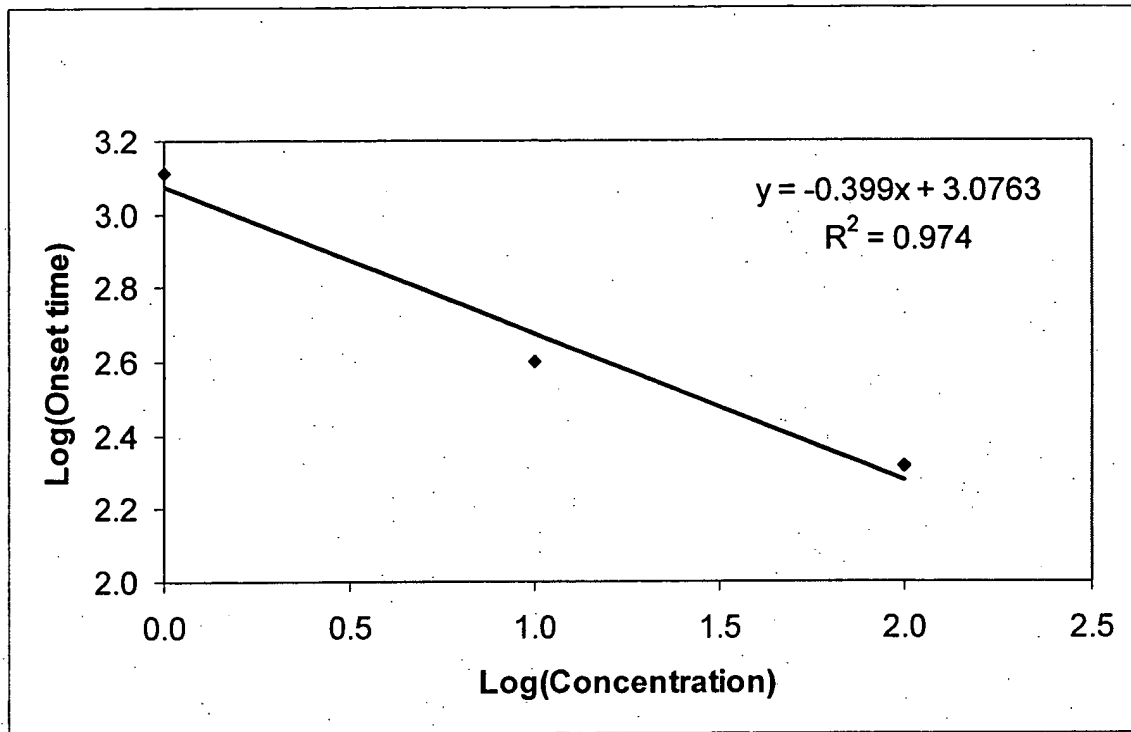

Figure 17

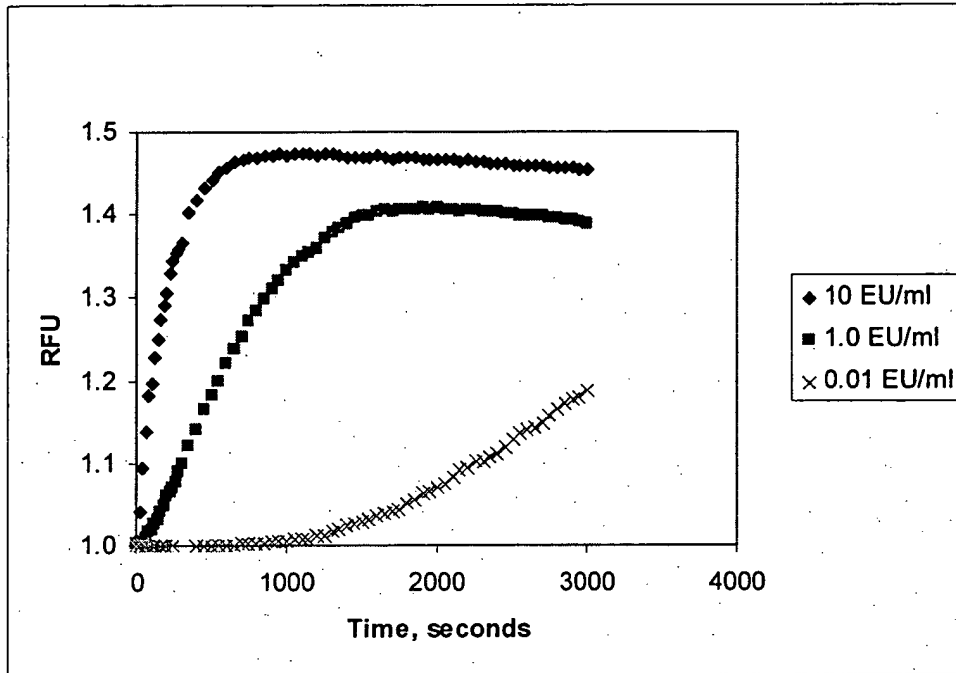

Figure 18

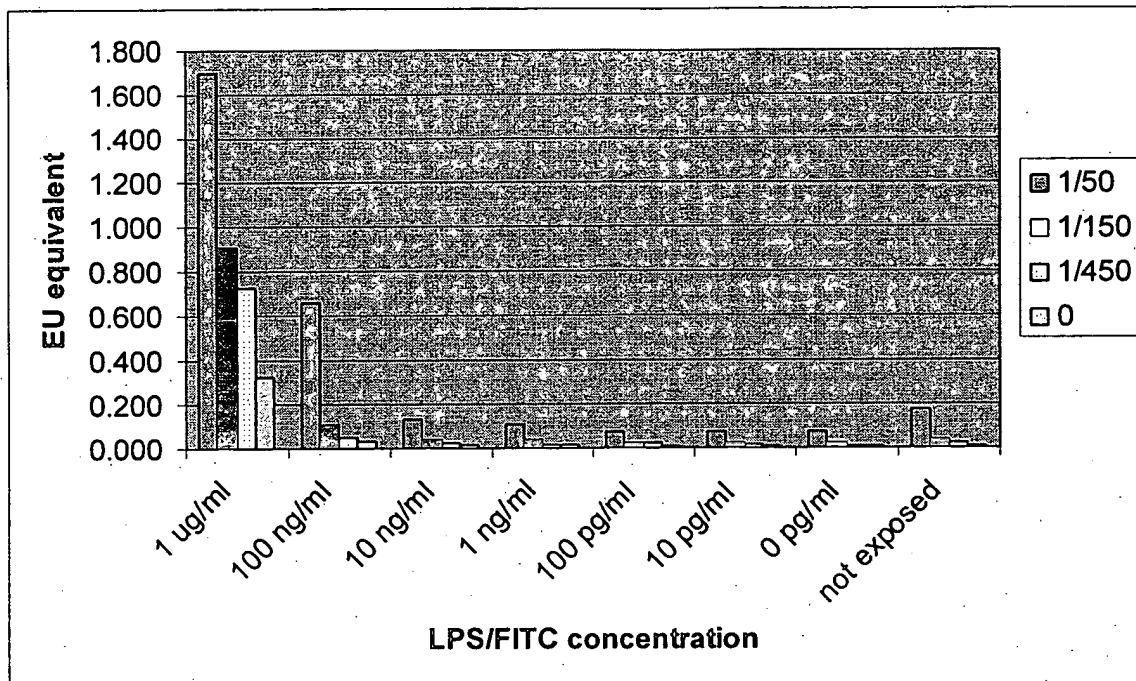

Figure 19